

PARK

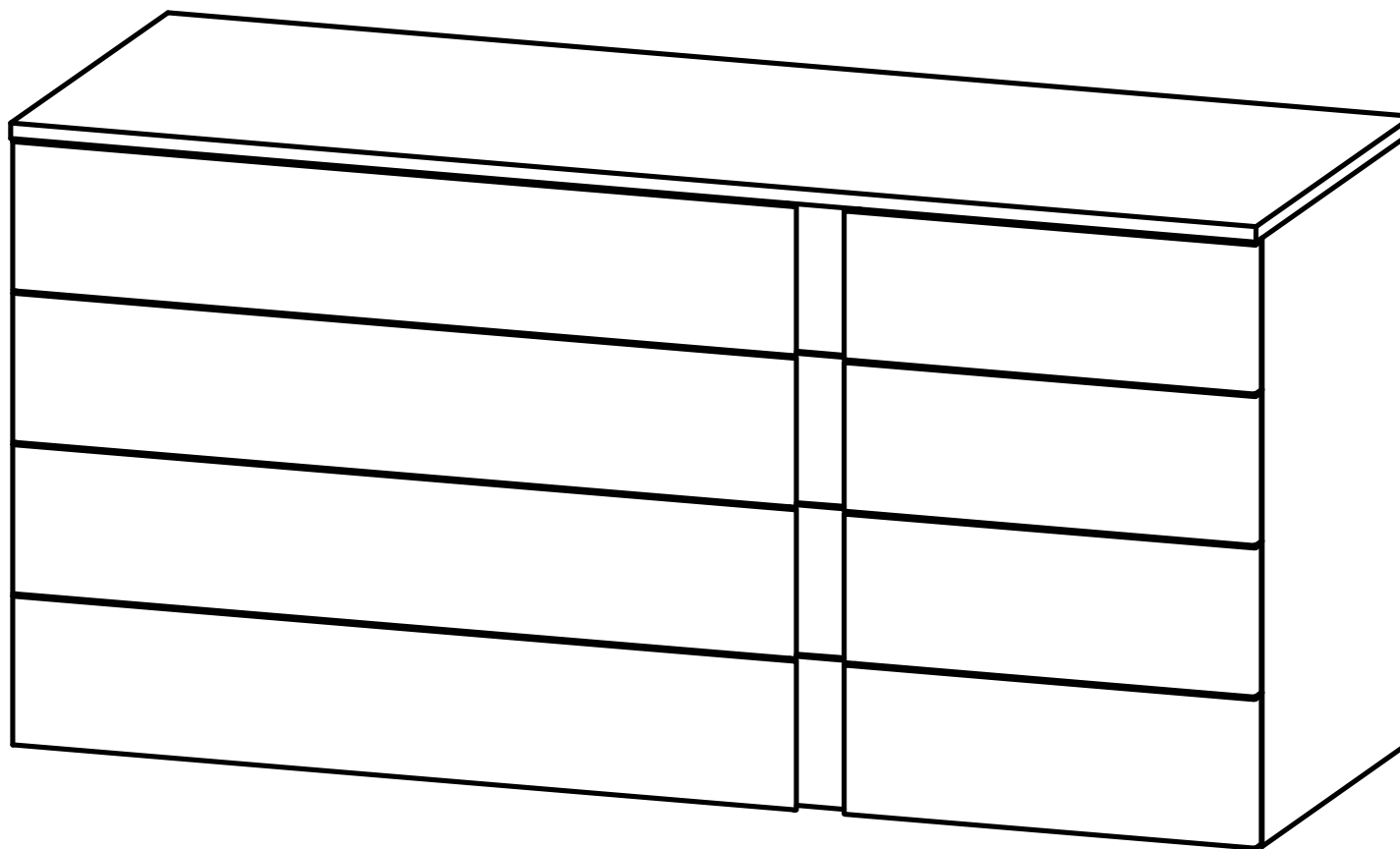

MODLOFT



ASSEMBLY INSTRUCTION

MD318-DR

PARTS

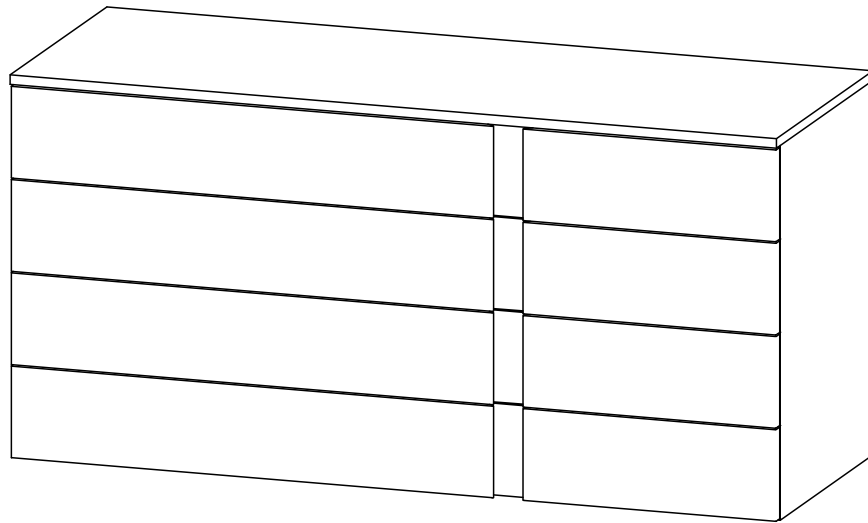

① x 1

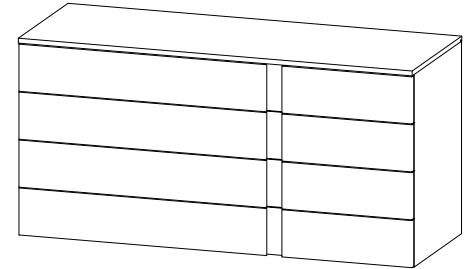

② x 6

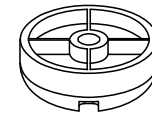

③ x 6



HARDWARE

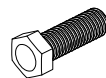

M8x25mm

Ⓐ x 6

TOOL

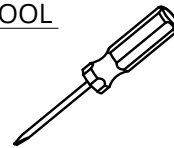

Ⓑ x 1



ASSEMBLY INSTRUCTION

MD318-DR

STEP 1

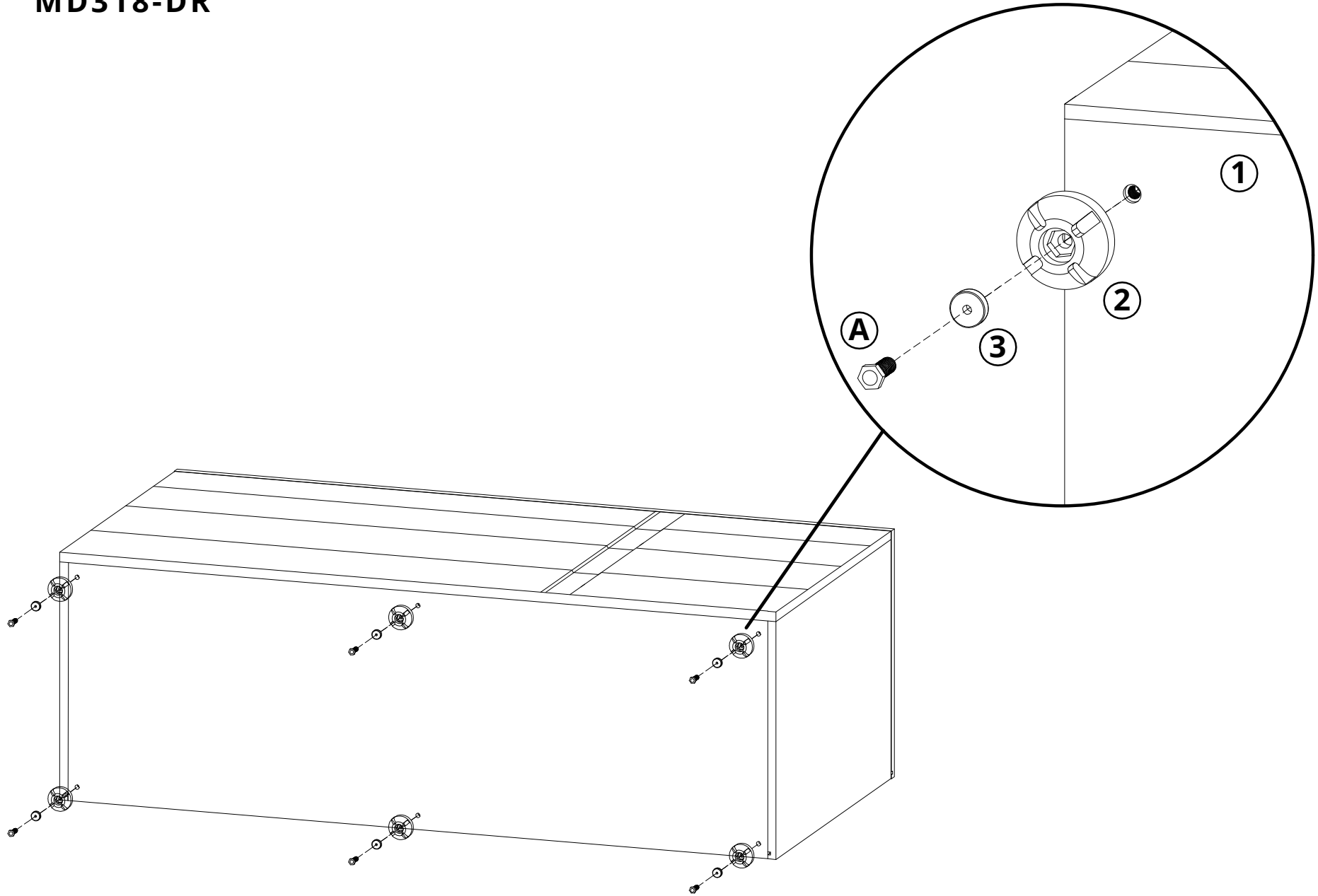



ASSEMBLY INSTRUCTION

MD318-DR

STEP 2

