

MD317-Q Assembly Instructions

Parts

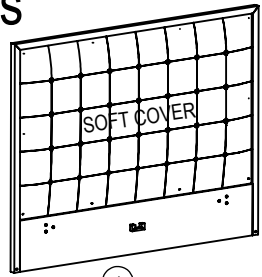

① x1

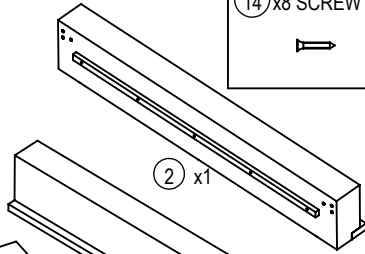

② x1

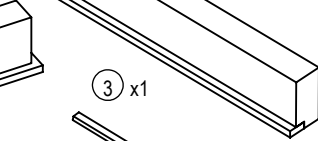

③ x1

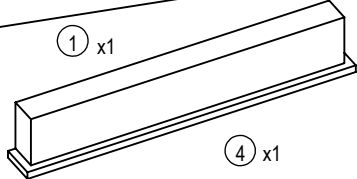

④ x1

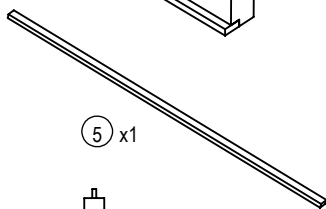

⑤ x1

⑦ x1

⑥ x3

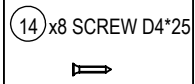

⑭ x8 SCREW D4*25

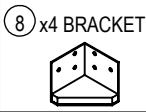

⑧ x4 BRACKET

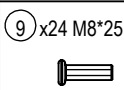

⑨ x24 M8*25

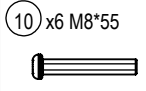

⑩ x6 M8*55

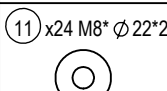

⑪ x24 M8* Ø22*2

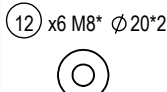

⑫ x6 M8* Ø20*2

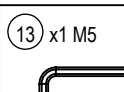

⑬ x1 M5

1:

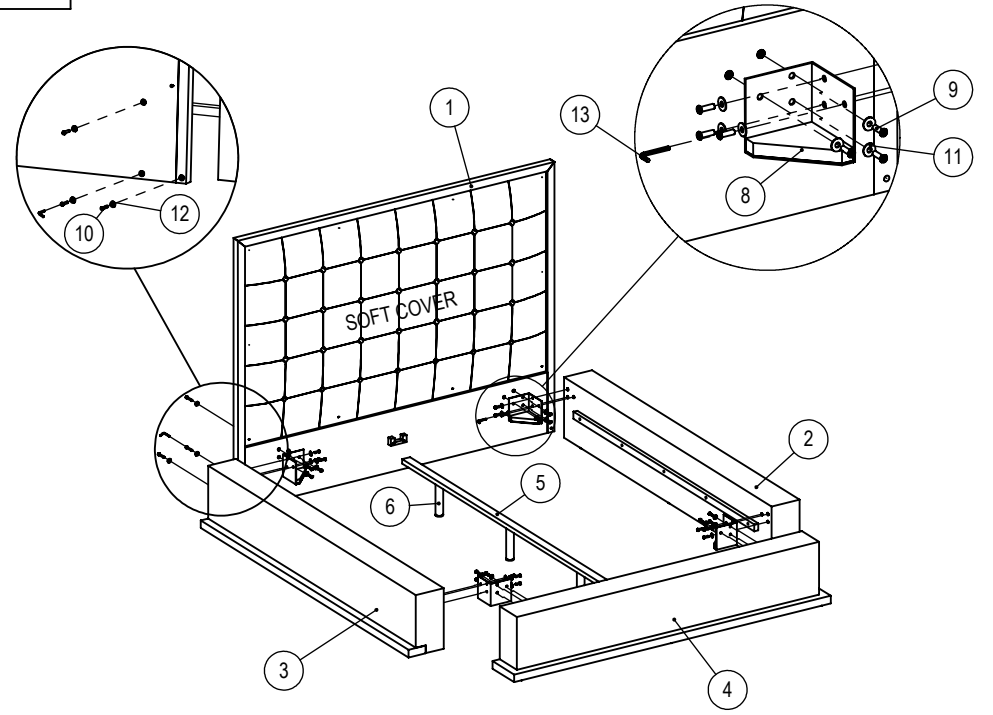

2:

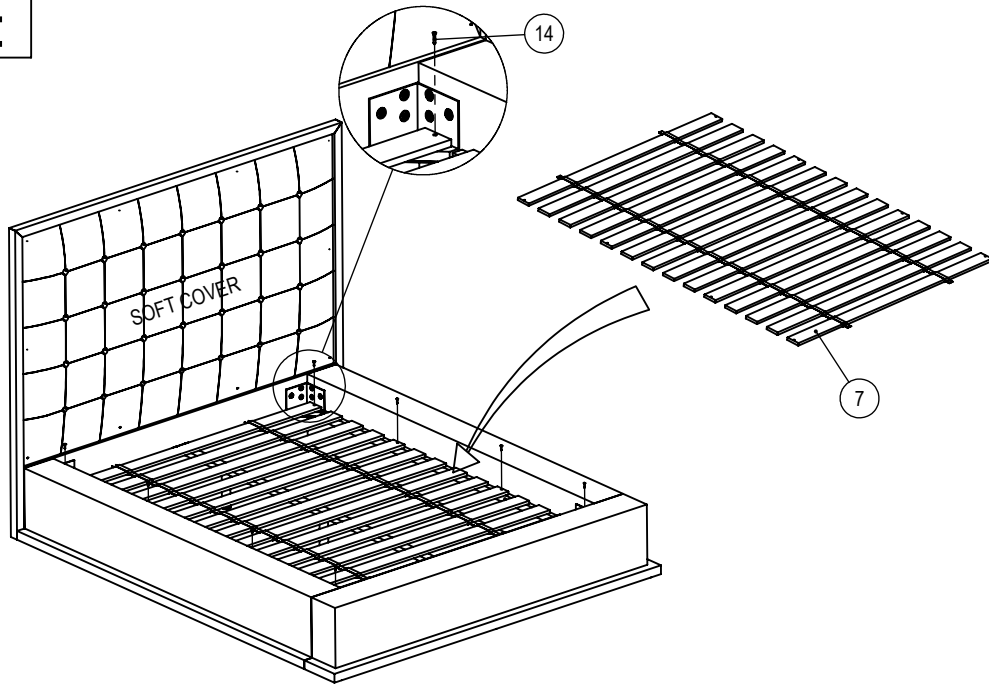

3:

