

ASSEMBLY INSTRUCTION RIVINGTON - QUEEN BED

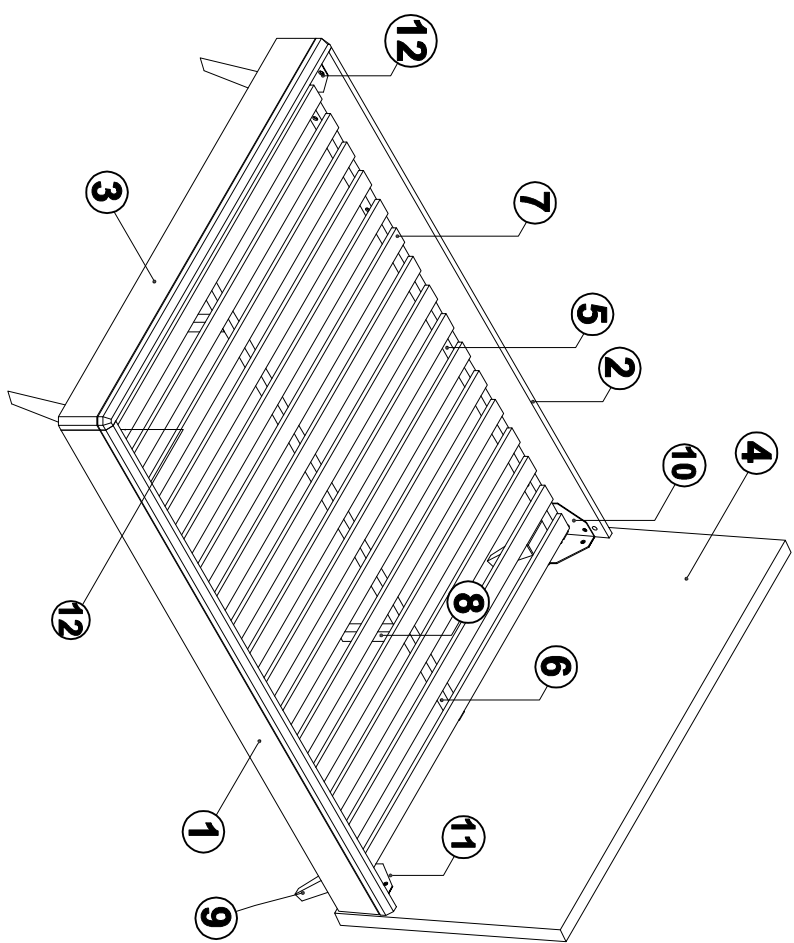

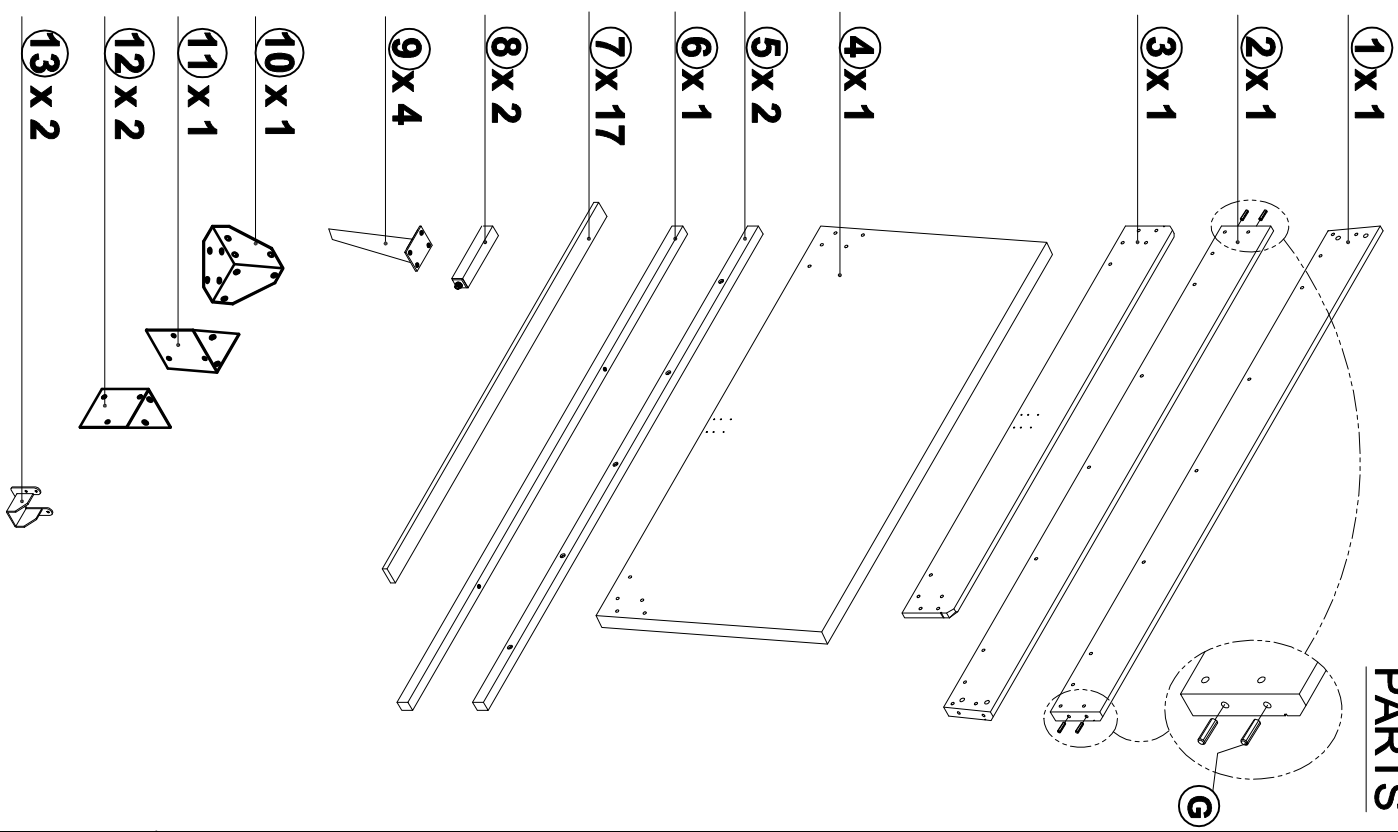



PARTS

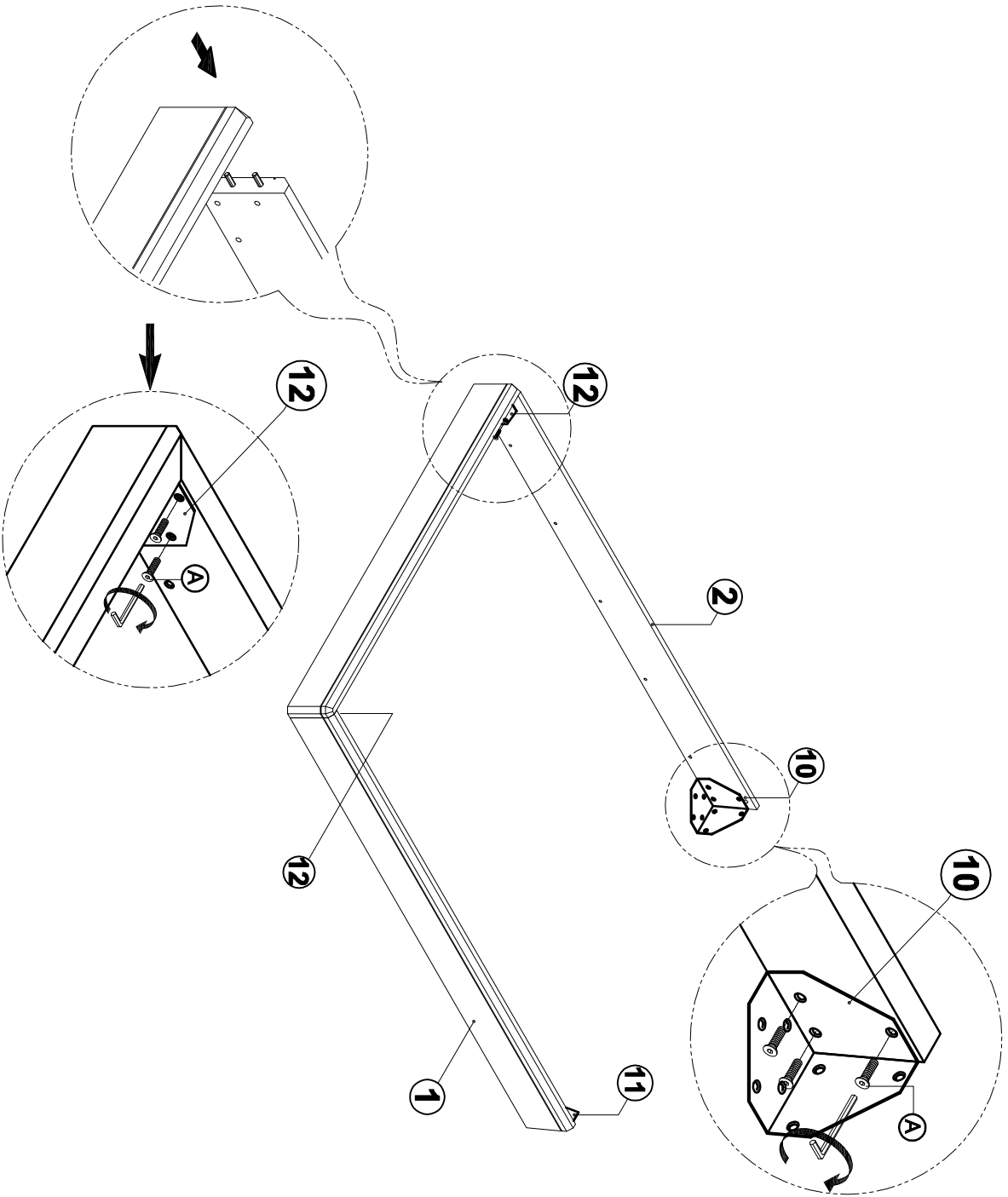

STEP 1

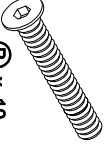
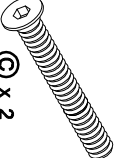
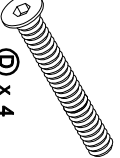
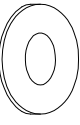

HARDWARE

-  **A** x 40
(M8 x 15)
-  **B** x 10
(M8 x 50)
-  **C** x 2
(M8 x 60)
-  **D** x 4
(M8 x 100)
-  **E** x 16
(WASHER (8x20))
-  **F** x 16
(NUT M8)
-  **G** x 4
(DOWEL)
-  **H** x 8
(M4 x 15)

TOOL

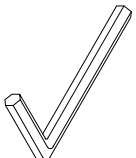
-  **I**
(WRENCH 13)
-  **J**
(ALLEN KEY 4)

STEP 2

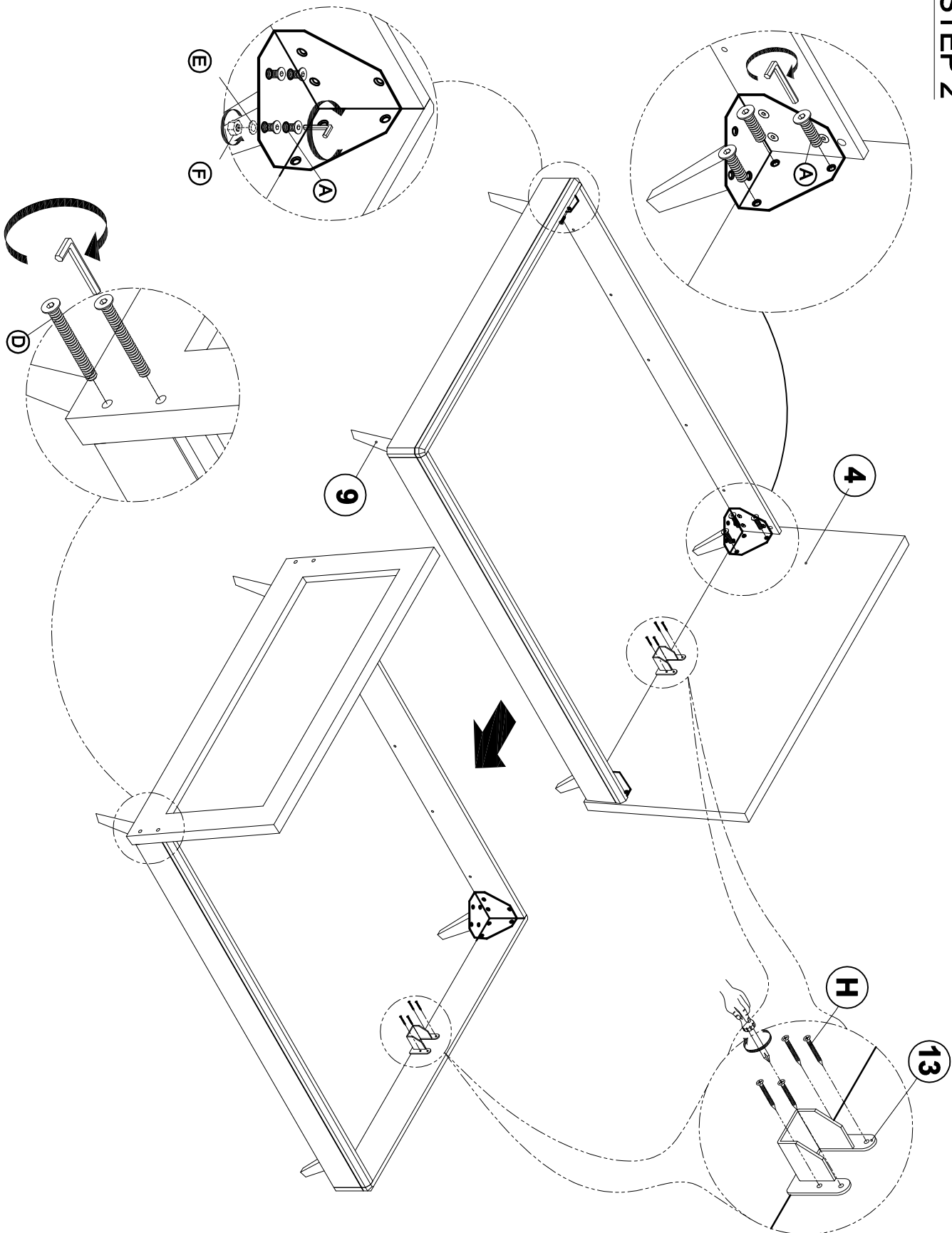

STEP 3

