

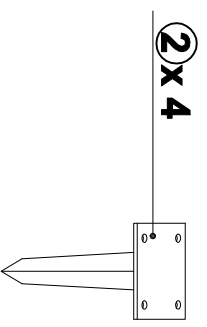

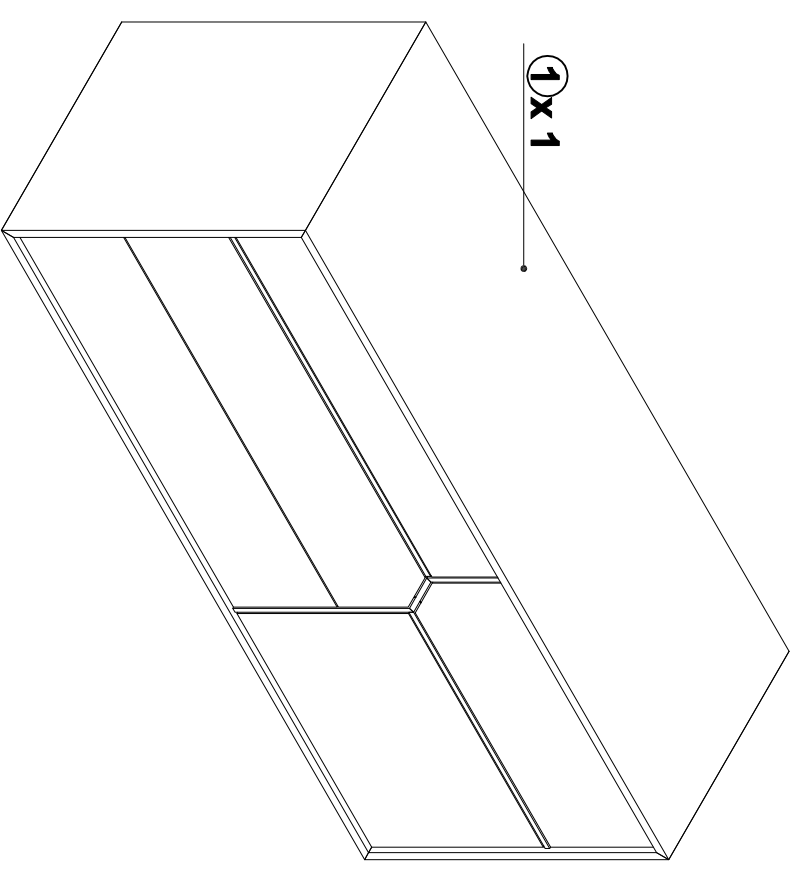

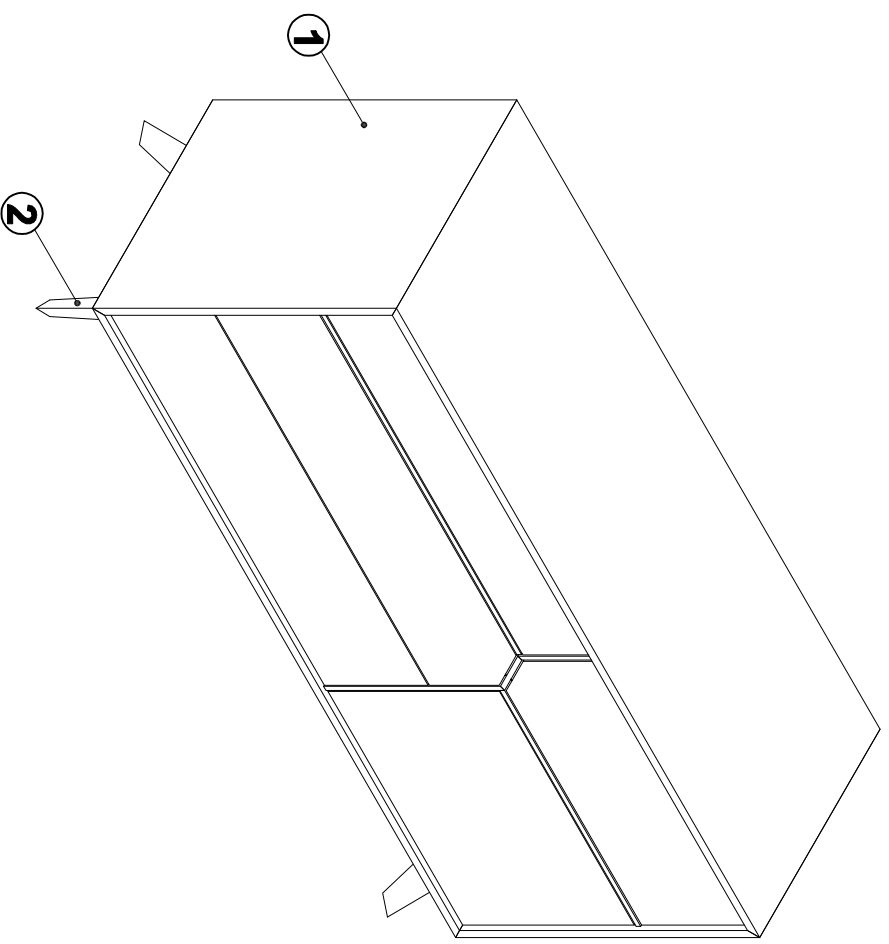



ASSEMBLY INSTRUCTION

RIVINGTON - DRESSER



 A x 17 (M8 x 20)	 WASHER (8x20) B x 11	 STRAPS C x 1	 PLASTIC STOPPER D x 1	 E x 1 (M5 x 50)	 WASHER (6x13) F x 1	 ALLEN KEY TORX M6
--	--	--	---	---	---	--

STEP 1

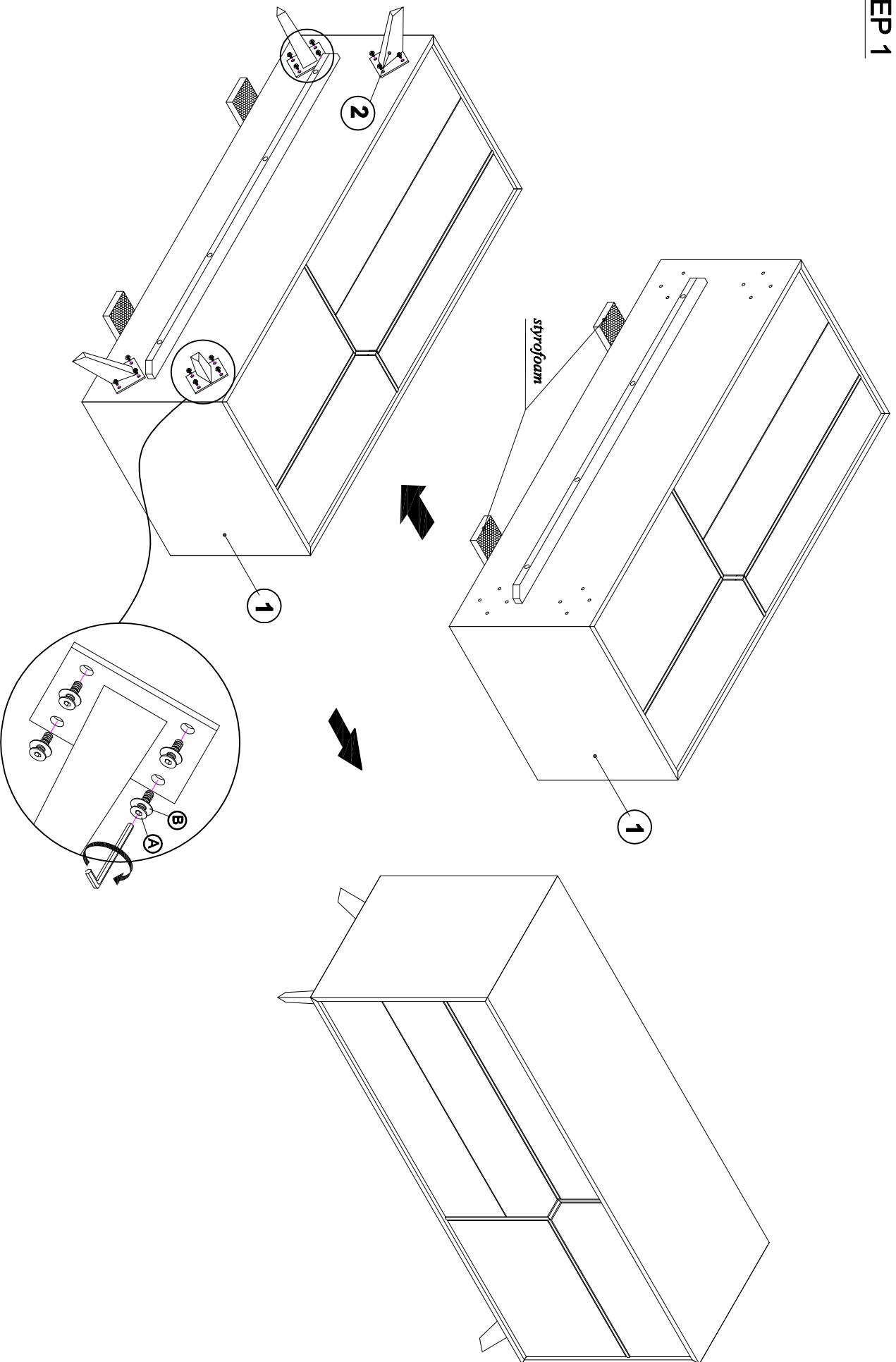

Caution:

- * When attaching the legs, please do not put the cabinet directly on floor to avoid damaging the product.
- * Please put the cabinet gently on the styrofoam to protect the product while attaching the legs.
- * When attaching the table stretcher bar to metal leg, put all screws lightly in place before tightening them.
- * To protect the product, do not use too much force when tightening the screws.

STEP 4

