

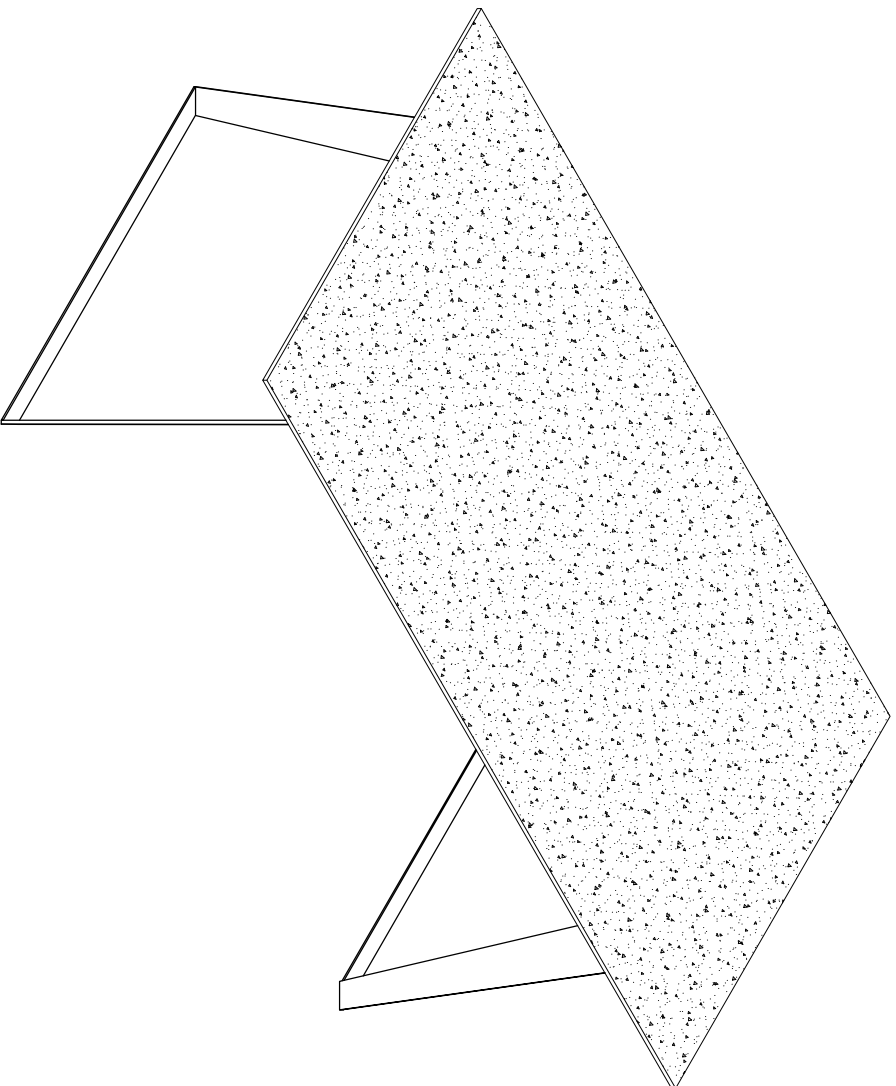

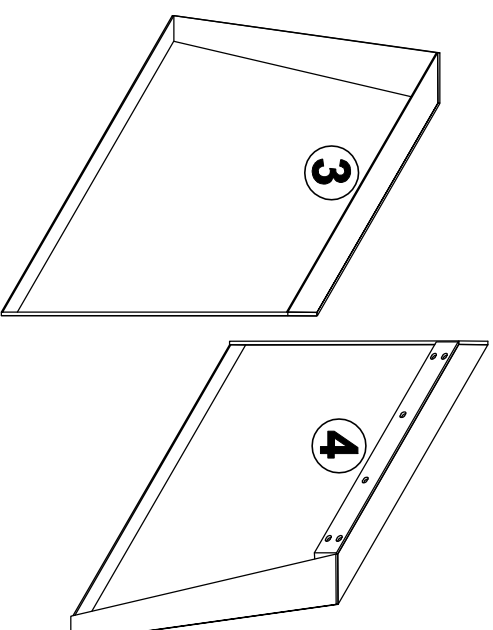

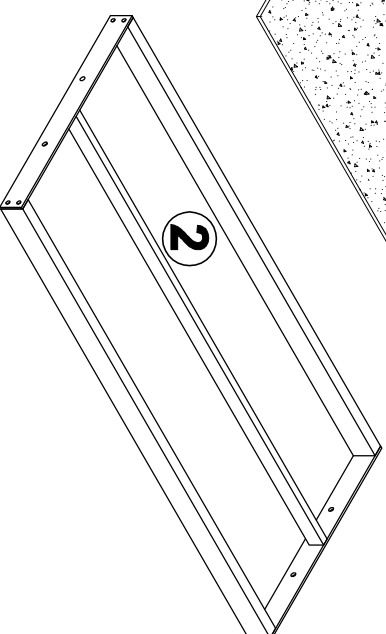

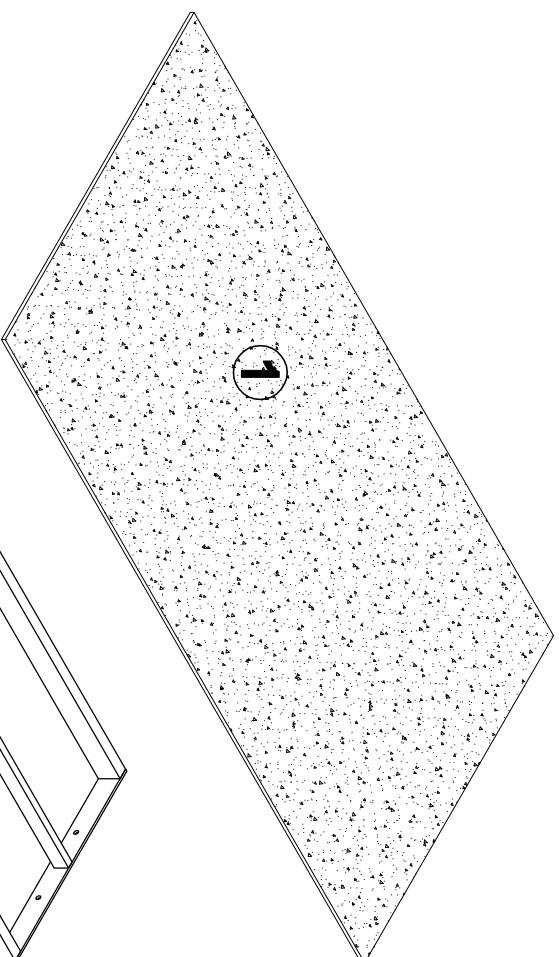



ASSEMBLY INSTRUCTION

AMSTERDAM - DINING TABLE - CEMENT TOP



Please note: the metal leg frame is not connected to the tabletop. The weight of the tabletop makes this unnecessary. This means, you only have to assemble the leg frame and then place the cement tabletop on the frame and you are done.



HARDWARE	
 A x 8 (M10 x 30)	 C x 4 (M8 x 25)
 D x 4 (NUT M8)	 E x 8 WASHER (10x16)
 F x 8 WASHER (8x20)	
TOOL	
	
	

STEP 1

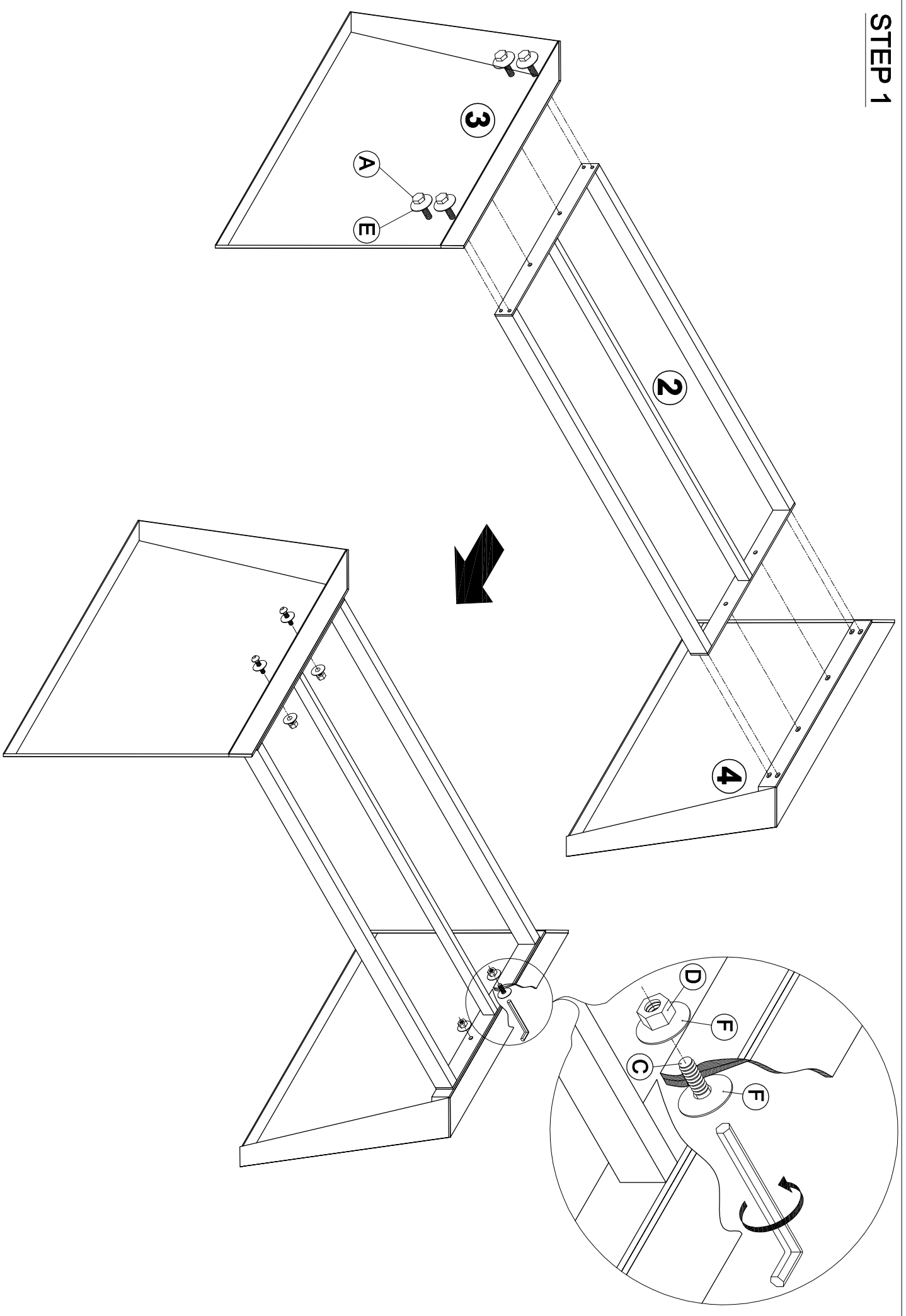

STEP 2

